

Roofit.Solar

# Velario Safety and Installation Manual



# Table of Contents

<b>Acronyms</b>	<b>3</b>
<b>Definitions</b>	<b>3</b>
<b>Introduction</b>	<b>4</b>
<b>Disclaimer of Liability</b>	<b>4</b>
<b>Safety</b>	<b>5</b>
General Considerations	5
Main Precautions	6
Fire Safety	7
<b>Roofit.Solar Product Information</b>	<b>8</b>
Illustration of the Product	8
Connectors	9
Bypass diodes	9
<b>PV system planning</b>	<b>10</b>
Prevention of the shadows	10
Roof Support Structure	10
Measuring the roof	13
Planning the layout	13
<b>Electrical interconnection</b>	<b>14</b>
Electrical connection accessories	14
Series and Parallel Wiring	16
Grounding	17
<b>Mechanical Installation</b>	<b>18</b>
Accessories for installation	18
Cutting of the seams	19
Seaming of the double seam profile	21
Installation instructions	22
Case 1: Roof fully covered with Roofit.solar modules	22
Case 2: The column starts with a regular metal sheet	25
Case 3: The column ends with a regular metal sheet	26
<b>Maintenance</b>	<b>27</b>
Cleaning	27
Visual inspection	27
Decommissioning and Disposal	28
<b>Customer Support</b>	<b>28</b>

## → Acronyms

<b>BIPV</b>	Building Integrated Photovoltaics (i.e. metal integrated photovoltaics)
<b>DC</b>	Direct Current
<b>JB</b>	Junction box
<b>m.a.s.l.</b>	Meters above sea level
<b>PV</b>	Photovoltaic
<b>STC</b>	Standard Test Conditions (T= 25°C, Solar Irradiance = 1000 W/m <sup>2</sup> , AM = 1.5)
<b>VDC</b>	Volts of direct current

## → Definitions

<b>Buyer</b>	A person or party that purchases the Product/s from the Roofit Solar Energy OÜ.
<b>Product/s</b>	Roofit Solar Energy OÜ BIPV (i.e.i.e., metal integrated photovoltaics)
<b>Warranty Period</b>	The period beginning on the date of purchase of Product/s by the Buyer
<b>PV layer</b>	The Photovoltaic part of the Roofit.Solar Product
<b>PV system</b>	System composed of two or more Roofit.solar Products combined with an inverter and other electrical accessories.

## Introduction

This manual contains essential information safety information about electrical and mechanical installation that must be followed before handling, installing, and maintaining Products of Roofit Solar Energy OÜ. Installers must follow all safety precautions described in this guide as well as local codes when installing a Product.

## Disclaimer of Liability

All the information contained in this manual is the intellectual property of Roofit Solar Energy OÜ and is based on the technologies and experience acquired and accumulated by the company. This manual does not constitute a warranty, either explicit or implicit. Roofit Solar Energy OÜ does not assume responsibility and expressly disclaims liability for any loss, damage, or expenses arising from or in any way related to the installation, operation, use or maintenance of our Product. Roofit Solar Energy OÜ assumes no responsibility for any infringements of patents or other rights of third parties that may result from the use of our Product.

Roofit Solar Energy OÜ reserves the right to make changes to the Product, the specifications, or the installation manual without prior notice. Latest versions will be available on our website <https://roofit.solar/>. Failure to comply with the requirements listed in this manual will void the warranty provided by the Roofit Solar Energy OÜ.

The mechanical and electrical installation of PV systems must be carried out with all applicable codes, including electrical codes, building codes and electric utility interconnection requirements. These requirements may vary from country to country. Contact local authorities for applicable regulations. The product must be installed by a qualified person. The electrical connection must be made by a certified electrician. Planning the location of the product on the roof should be carried out by a competent professional with experience in planning PV systems.



# Safety

## General Considerations

**The distributor of our Products is required to provide this manual to the PV system owners.**

The Product is designed to meet the requirements of the IEC 61215 and IEC 61730 standards. Perform structural analysis of the roof before installing Roofit.Solar Products.

Observe all relevant laws, regulations, guidelines, and safety measures when handling solar modules. For your safety, do not attempt to work on a rooftop until the necessary safety precautions have been identified and taken. Sufficient protective equipment (e.g., harnesses, insulated rubber gloves and tools, etc.) is required throughout the installation process.

Roofit.Solar Products can be combined with other components to form a photovoltaic system. In this case, installation and operating instructions issued for these additional components must also be followed.

NB! PV system generates DC electricity when exposed to light and therefore can cause an electrical shock or burn if not handled properly. PV modules are running on voltage higher than 30VDC and currents exceeding 30mA, thus all contacts with bare wires without proper safety measures can be dangerous for health. The danger increases when multiple Products are connected to provide higher system voltage or current levels. Dangerous voltages can also occur at night or even when the modules are not connected to an electrical circuit or load.

The Products can only be rendered inoperative by removing them from sunlight, or by fully covering their front side with fabric, cardboard, or other completely opaque material, or by working with Products face down on a smooth, flat surface.

A PV system can produce a higher output than the rated specifications. Industry standard ratings are made at STC. Reflection from snow or water can increase sunlight, therefore boosting current performance and power. In addition, colder temperatures can substantially increase voltage and power. This must be taken into consideration during the system design done by a competent person experienced in PV system planning (for more information see the section "Electrical Installation").



## Main Precautions

### Always follow the safety precautions listed below when dealing with Roofit.Solar Product:

- Do not keep the Product packages open outdoors until they are ready to be installed.
- Transport and store the Products in appropriate packaging in a ventilated, rainproof, and dry location.
- Always use electrically insulated tools and gloves while working on the electrical connection of the Product.
- Be careful with the sharp edges and corners of the Product.
- DO NOT disconnect/connect electrical connections under load.
- DO NOT install the Product in adverse conditions (rain, strong or gusty winds, wet or snowy roof surfaces, etc.).
- DO NOT use mirrors or other magnifiers to concentrate sunlight onto the Product.
- DO NOT overbend or apply stress to the cables.
- Observe the recommended cable bend radius following the supplier's data sheet.



- Ensure that all electrical connections are properly secured and protected from unwanted interference.
- Before installation, make sure that all the QC4:10 connectors have dust caps on.
- Remove the dust caps only prior making electrical connections.
- DO NOT lift the Product by holding it from the junction box or cables.
- DO NOT place the product in a way that there is a load applied onto junction box of cables.
- DO NOT attempt to install or service the PV system unless you are qualified to do so.
- DO NOT attempt to open the junction box, repair, modify or disassemble the Product.
- DO NOT leave the Product unsecured. If it falls, the glass layer could break.  
The Product with a broken glass layer cannot be repaired and must not be installed.
- DO NOT apply paint or adhesive to the Product surface or attempt to remove any markings, labels or parts attached to the Product by the manufacturer.
- DO NOT drill holes in the PV layer of the Product.
- Always mount the Product so that the junction box is unobstructed and does not carry any of the weight of the Product.
- Avoid stepping or placing heavy load on the modules during the installation.  
Doing so may cause microcracks/ cracks that are invisible to human eye and therefore reduce the reliability of the Product and lead to withdrawal of the warranty.  
Roofing metal or metal parv of the PV module can only be cut with metal scissors or low-speed circular saw.

## Fire Safety

Consult your local authority for guidelines and requirements for building or structural fire safety.

Roofit.Solar Products have been tested according to the Fire Test in IEC 61730 Part 2 and classified as Class A. Also, Roofit.Solar Products have been tested according to CEN/TS 1187 and labelled as Broof (t2) in accordance with EN 13501-5:2016. In addition, the metal sheet has been tested according to the EN 14782:2006 “Self-supporting metal sheet for roofing, external cladding, and internal lining.”

Roof constructions and installations may affect the fire safety of buildings.

Improper installation may lead to hazards in the event of a fire.

Use appropriate components such as fuses and grounding connectors as required by the local authorities.

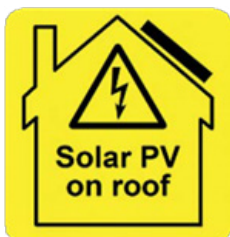

**Inform firefighters about the existence of a photo-voltaic system in the building.**



**In case of fire, stay away from all elements of the PV system, until the area is safe.**

Roofit.Solar recommends using a combiner box for buildings with PV systems to protect the house and inverter(s) from unexpected overvoltage.

The combiner box is equipped with an emergency disconnect mechanism that shuts down the PV system and protects it from overvoltage caused by the lightning strikes.

The combiner box includes a fireman's switch, which disconnects the DC power lines between the solar modules and the inverter(s). The device can be triggered locally, as it is installed outside of the building, providing easy access in case of a fire.

Please, follow the combiner box instructions during the connection to the system, as in most cases the maximum distance between the combiner box and the PV modules must not exceed 10 meters of cable length. If this distance is exceeded, an additional combiner box needs to be installed.

# Roofit.Solar Product Information

The Roofit.Solar product is a building-integrated photovoltaic (BIPV) system that can be used as a construction material on roofs or building facades. General information about the components of Roofit.Solar PV module is depicted in the pictures below. Detailed information about their electrical, mechanical, and thermal characteristics can be found in datasheets of the products.

## Illustration of the Product

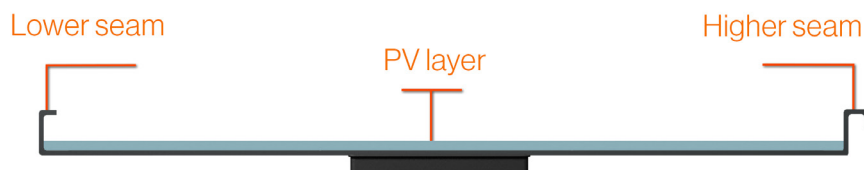
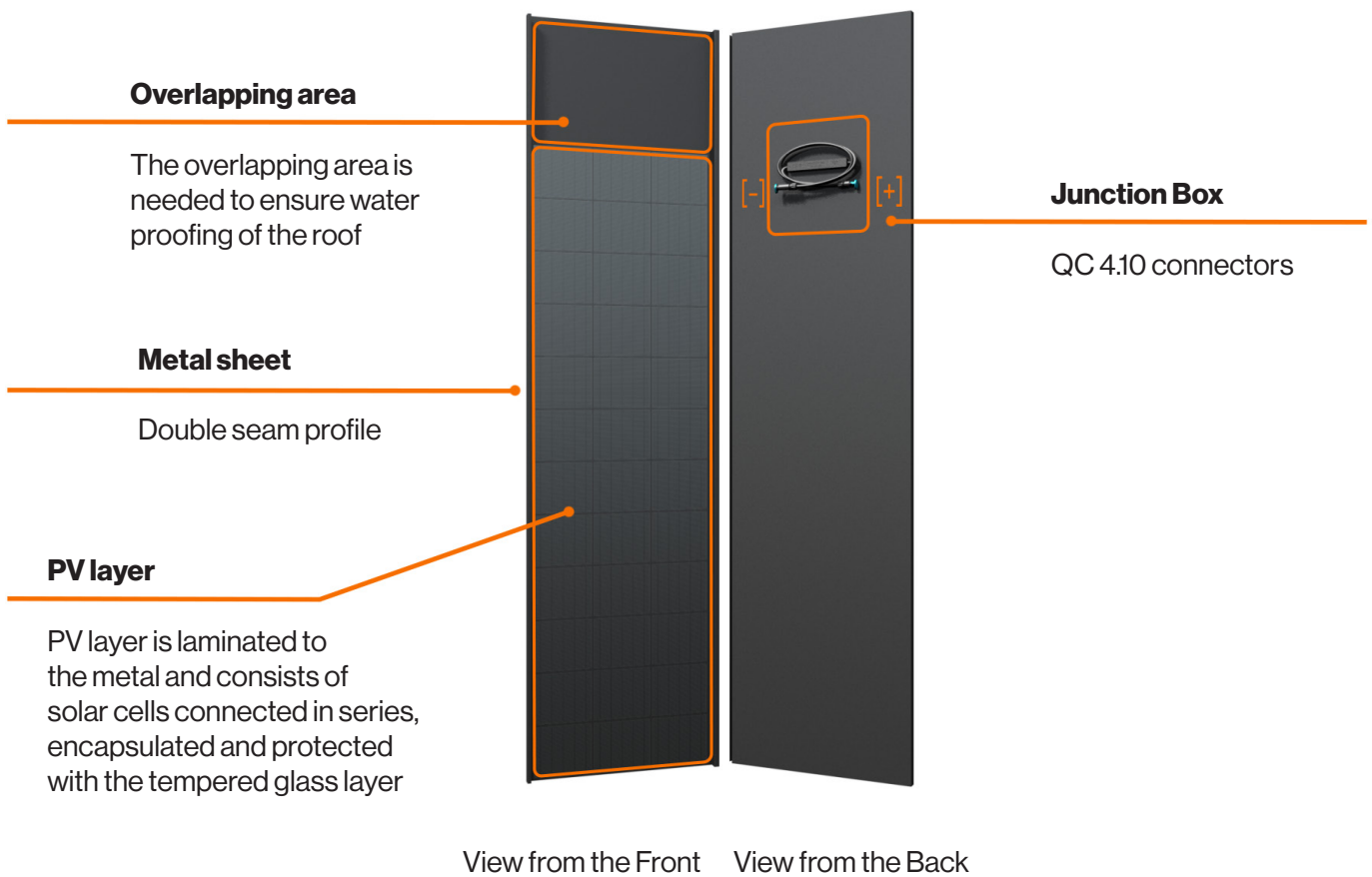

View from the Bottom Edge



## Connectors

Roofit.Solar Product has a junction box containing positive and negative QC4.10 terminals.  
The junction box has been designed to be electrically interconnected in series with IP68 protection grade.

Type	Ambient temperature	Degree of protection	Rated voltage	Rated current
QC4.10 Connectors	-40 to + 85 °C	IP68	1500 V	41A

## Bypass diodes

The junction box contains three bypass diodes wired in parallel with the PV cell strings.  
In case of partial shading, the diodes bypass the current generated by the unshaded cells, thereby limiting the Product heating. Product must not be installed under constant shadows, bypass diodes only protect from partial shading. Bypass diodes are not overcurrent protection devices.  
In the event of a known or suspected diode failure, installers or maintenance providers should contact the supplier.

Rated bypass current	Rated reverse current	Rated voltage	Operating Temperature
16 A	30 A	1500 VDC	-40 to +200 °C

## PV system planning

Proper measures must be taken to ensure the performance and safety of the Product when installed or operated in areas with heavy snow, extreme cold, strong wind, near coastal areas or deserts where salt fog may manifest.

The operating temperature range of the product is between  $-40^{\circ}\text{C}$  and  $85^{\circ}\text{C}$ .

The maximum altitude for the installation of a 1000 V Roofit.Solar Product is 2000 m.a.s.l.

Ensure the Product is not subject to wind or snow exceeding the maximum permissible load.

The maximum permissible designed snow load is 4000 Pa with a safety factor of 1,5.

The maximum permissible designed wind load is 1600 Pa with a safety factor of 1,5.

Roofit.Solar is not responsible or liable for Products damaged during lightning. Therefore, surge protection is recommended for Products to be installed in locations with high probability of lightning strikes.

The Product should not be installed in locations where any type of corrosive agents and/or flammable gases may be generated or collected.

### **Prevention of the shadows**

Modules must not be permanently shaded (including partial shading, spot shading, uniform shading, or uneven shading). Permanent shading includes shading of a module cell, module cell row, or module section over an extended and repeated period of time. Power directed into shaded or partially shaded module cells causes power loss, reduces productivity, and can cause localized overheating, which in turn can negatively affect the life of the module. Permanent shading can cause accelerated aging of the encapsulation material and increase the thermal stress of the bypass diodes. The above would void the module's warranty if not properly reduced.

Regular maintenance is required to keep the modules clean.

Special care should be taken to avoid shading from dirt and debris (e.g. tree leaves, bird droppings).

To avoid permanent shading, do not install the modules directly behind any objects (eg trees, antennas, chimneys).

A module whose entire surface is not shaded all year round can be considered unshaded.

### **Roof Support Structure**

Ensure that the installation method and supporting system of the roofing materials are strong and durable enough to install the Product and meet its load requirements. The supporting system must be installed in accordance with local, national, or international standards.

Any penetration (e.g.chimney, pipes etc.) to the roof must be properly sealed to prevent leaks.

The back of the product must be kept free of foreign objects that are not part of the support structure.

Battens support the Product and must be installed on the same level and form a flat surface to reduce the chance of glass layer damage, provide proper locking quality, and decrease passive metal oil canning. Tolerance of  $\pm 15$  mm over 5m is allowed for unevenness of the battening in both vertical, horizontal, and diagonal direction. Leveled rafters and calibrated wood is the best practice for achieving that.

For the purposes of waterproofing as well as maintenance, the slope of the roof must be more than 10 degrees.

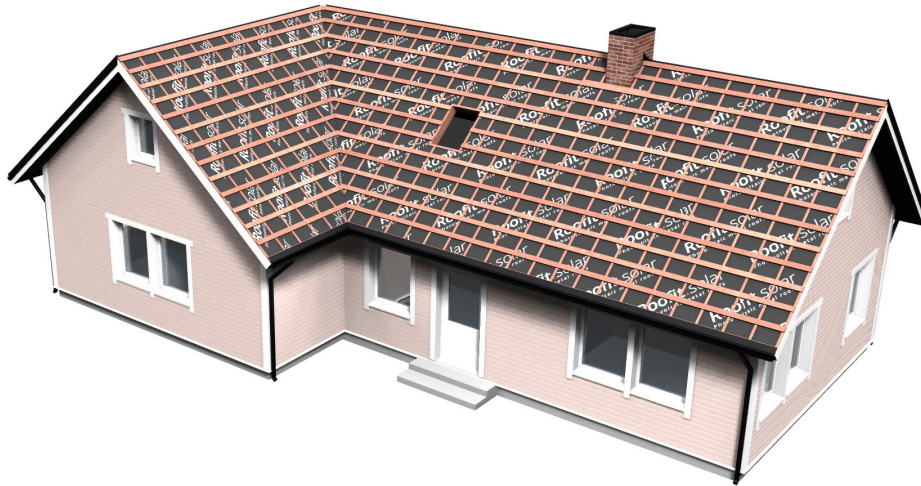

For the installation of the subframe, use wooden battens with dimensions of 32 x 100mm. The minimum and maximum allowed center-to-center batten spacing is 200 and 400mm respectively. Roofit.Solar best practices recommend using a spacing of 200mm to ensure adequate cooling and wind uplift resistance.

The minimum allowed ventilation gap between the Product and the moisture barrier is 50 mm, which can be achieved by using a ventilation board and batten of appropriate thicknesses. A minimum of 200mm from the bottom of the roof should be fully decked.

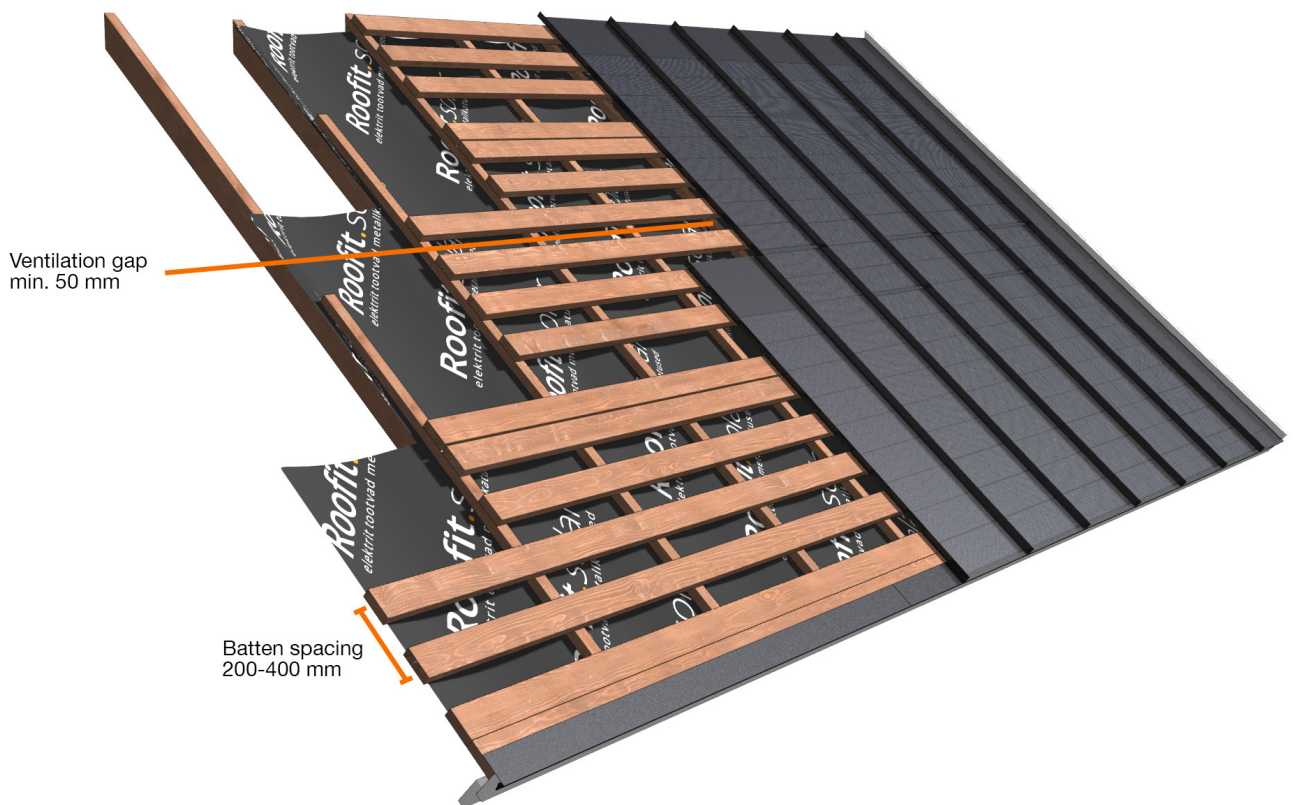

When installing the Product, make sure to pay attention to where the battens are placed in relation to the junction box. Each Product has a junction box that needs to be placed between the battens. To make sure everything fits and works correctly, you need to leave 100mm of space for the junction box, wires and any potential misplacements. If the battens are in the way of the junction box, move them up or down before installing the Product.

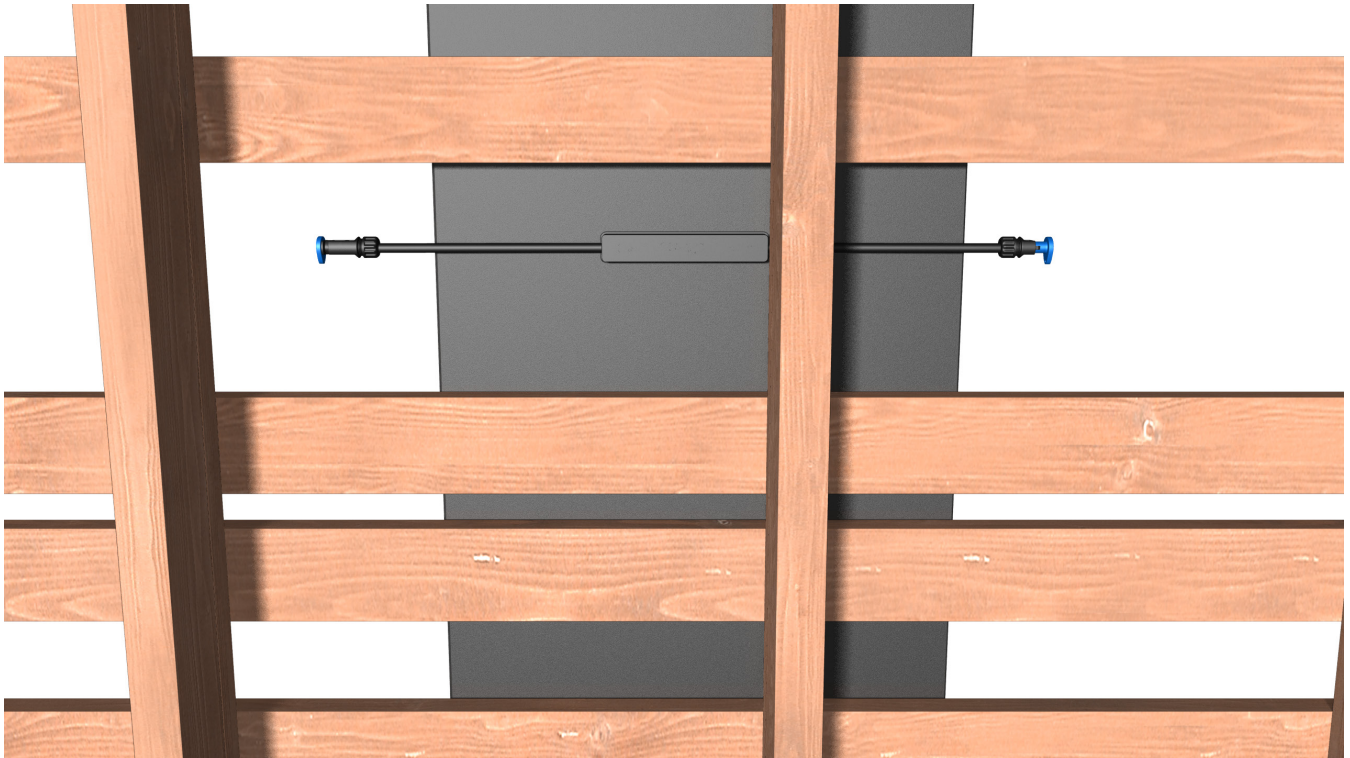



## Measuring the roof

The customer needs to provide Roofit.Solar with a drawing or a simple sketch of their roof with important measurements for the PV system. Length of the roof is measured from the outer surface of the farthest facing board from the eaves to the middle of the ridge.

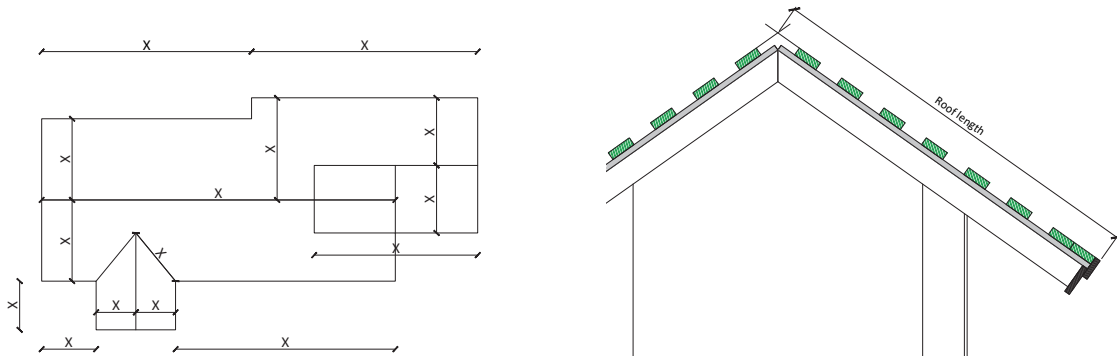

## Planning the layout

Roofit app software helps with roof planning by determining the most effective solar module placement based on the complexity of each roof. Shadow analysis determines the potential power loss from trees, chimneys, dormers, and other structures and determines the best location for solar modules. Snow guards, passage ladders, skylights, and personal demands from the Buyer are also factors in PV module layout. Roofit.Solar needs as much information about the roof as possible, including the estimated height of the chimneys, vent pipes, and trees in close proximity, in order to offer the most accurate design.

All penetrating roof elements (chimneys, skylights etc.) together with valleys must be surrounded with standard metal sheets with minimum 300mm from the element, as the PV layer of the Roofit.solar Product must not be cut, bent or other way stressed.

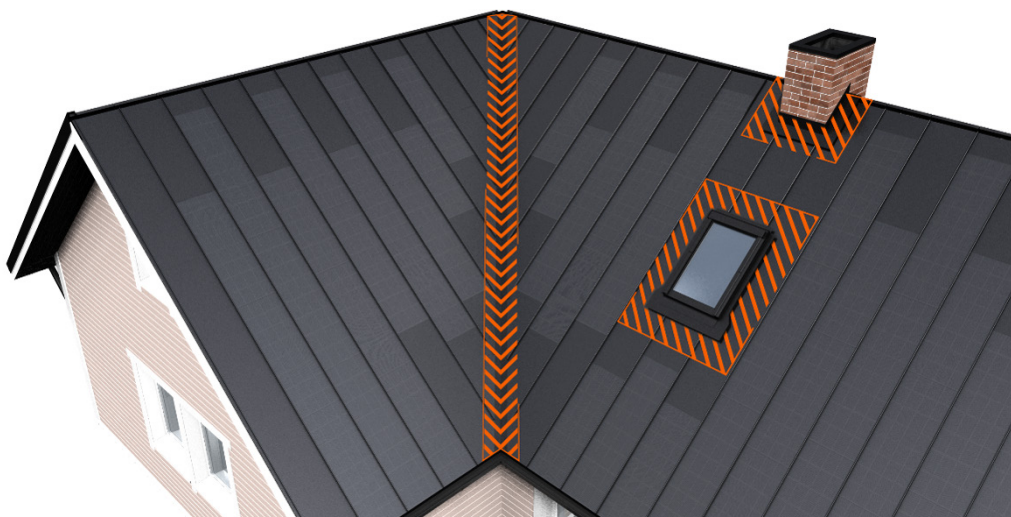

# → Electrical interconnection

## Electrical connection accessories

### Extension cable with QC4.10 male/female connectors



Extension cable (> 1 m)

Customized length.  
Extension cables are needed if the connection distance between the modules is more than 1 m.

### DC cable with QC4.10 male/female connectors



DC cables are used to connect Roofit.solar DC Strings with the inverter.

### Crimping pliers



To attach connectors to the inverter DC cable.

### Spanner



Spanner is used for the disassembly of connectors.

### Grounding cable

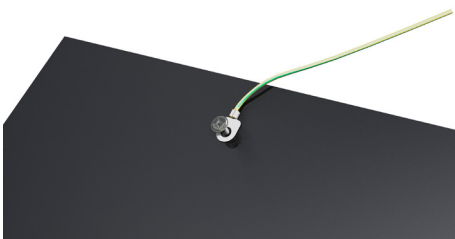



All wiring installation must be carried out by qualified installers in accordance with local electrical construction codes, procedures, and regulations.

All cables applied to connect the DC system must use copper wires with a cross-section area of at least 4 mm<sup>2</sup>, with double insulation and a designation code H1Z2Z2-K (according to EN 50618). The polarities of cables and terminals must be matched when making the connections, failure to do so may result in damage to the Product and to a person. Ensure that all electrical connections are secure and tight – confirm that you hear “click” to indicate that the connection is successful.

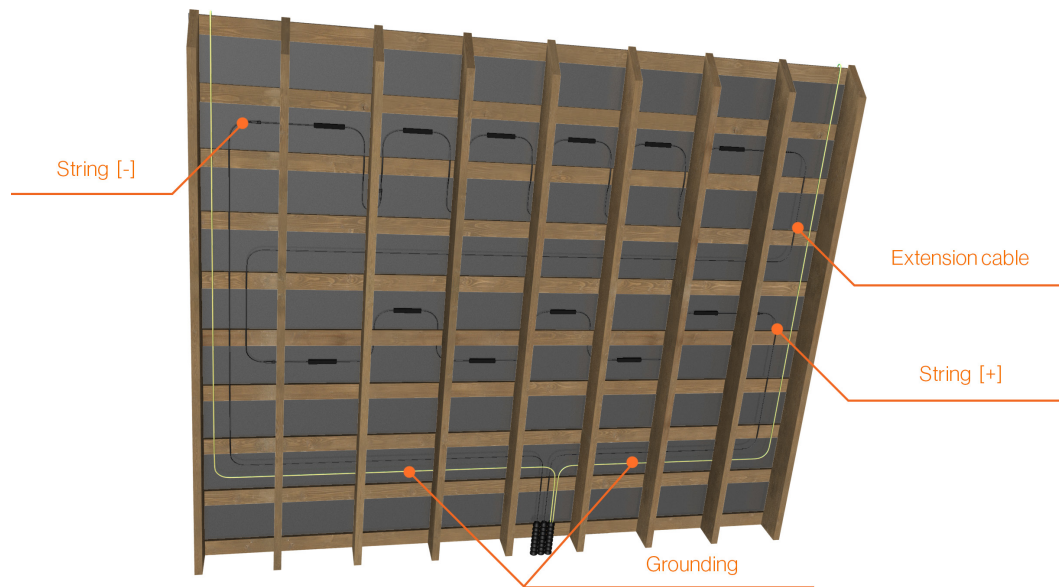

The inverter cables (String [-], String [+]), the grounding and extension cables connecting the Roofit.solar Products should be positioned on site (i.e. between battens) before the installation. Loose cables should be fixed to the wooden structure with the help of cable holder clips. In order for the PV system to maximize EMC (Electromagnetic compatibility) and to minimize the electromagnetic radiation, cabling should be positioned in a way to minimize the area of the wiring loop.

DO NOT group together positive, negative, and grounding cables to avoid ground fault and short circuit. Insulate bare DC cables and mark them accordingly for the time between PV system and inverter installation. Cables must be protected from any possible physical damages.

Each type of the cables should be separately routed to the protective tubes and taken to the technical room where they will later be connected to the inverter.

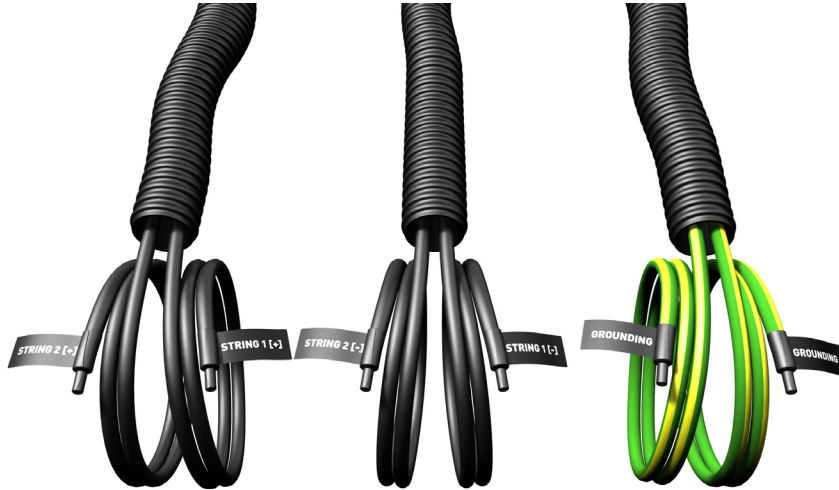

NB! Roofit.solar PV system must be equipped with DC arc fault circuit protection. DC arc- fault circuit protection provides supplementary protection against fires that may arise because of arcing faults in PV system components or wiring. Therefore, inverters with arc fault circuit interrupter (AFCI) must be used for the Roofit.solar PV system installation.

### Series and Parallel Wiring

Voltages are additive when Products are connected directly in series, and currents are additive when the Products are connected directly in parallel. PV circuits should be designed according to the best practice guidelines of the respective country.

The maximum number of Products that can be connected in series string must be calculated in accordance with applicable regulations so that the specified maximum system voltage of the Products and all other electrical DC components are not exceeded in open-circuit operation at the lowest temperature expected at the PV system location.

In addition, the maximum number of strings that can be connected in parallel cannot exceed 2 without proper protection. An overcurrent protection device is required for each series string if more than two series strings are connected in parallel. The maximum system voltage of the Roofit.Solar Product is DC 1000V according to the safety assessments of the IEC61730. The correction factor for the open-circuit voltage can be calculated based on the following formula:

$$C_{voc} = 1 - \beta * (25^{\circ}C - T_{min})$$

$T_{min}$ , °C is the lowest expected ambient temperature at the system site.  $\beta$ , %/°C is the temperature coefficient of the selected Product Voc (Refer to datasheet). A properly rated overcurrent protection device must be used when the reverse current could exceed the maximum fuse rating of the Product.

## Grounding

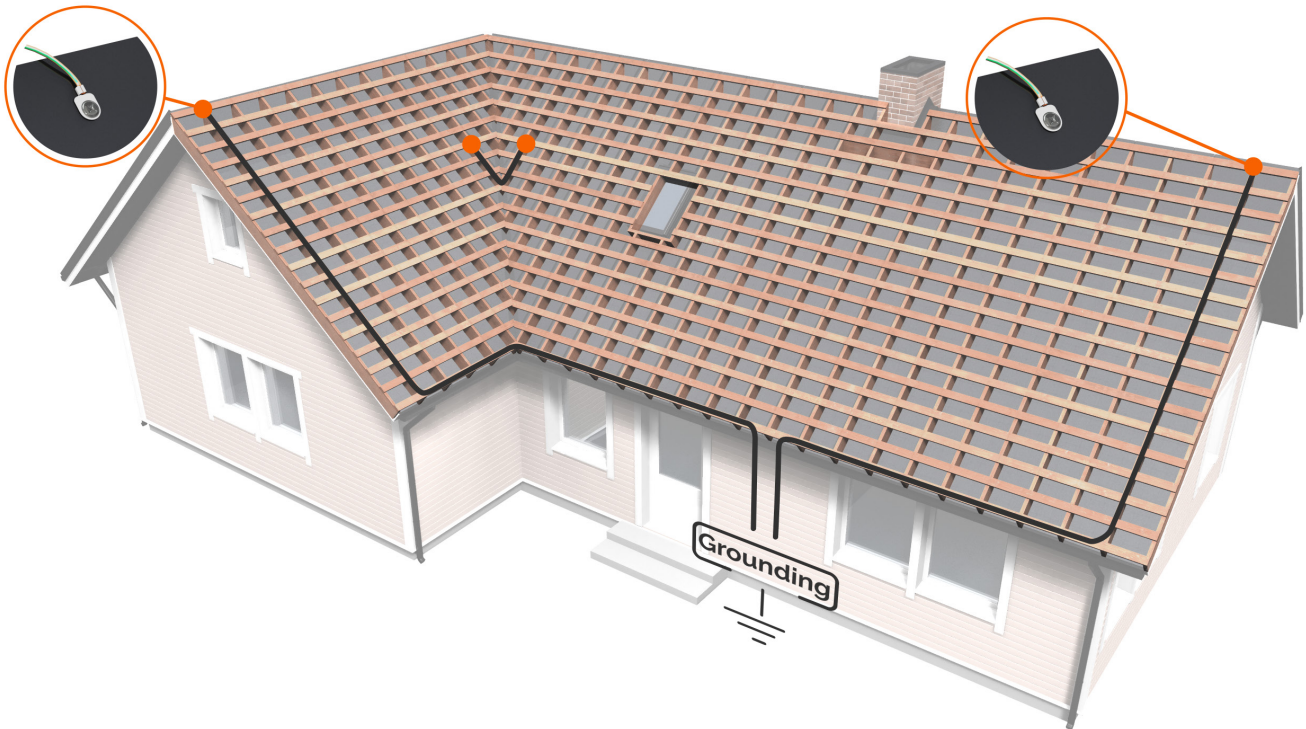

Each PV system must be connected to the grounding cable to ensure electrical safety. All Roofit.Solar products that are seamed with each other are galvanically connected. Roofit.Solar recommends 2 grounding cables per roof, to provide the possibility to measure ground connection quality.

If the building has more than one type of active surface on the roof (i.e., Roofit.Solar Products covering different sides of the roof), they can be connected in one grounding circuit to minimize the number of grounding cables as shown in the picture. Double grounding of the PV system is recommended even when applicable regulations, code requirements and standards do not require any safety-related grounding.

The grounding should be initialized by screwing a self-tapping A2 or A4 stainless steel screw, ST 4.8 according to DIN 7981C with a length between 10 mm and 16 mm. The screw is connected to the grounding conductor on the uppermost metal sheet of the roof under the ridge cap. The grounding is finalized by connecting the grounding conductors to the equipotential grounding.

# ➤ Mechanical Installation

## Accessories for installation

**Flat-head Screw**



Used for fixing fastening clips

**Butyl sealant**



Supports waterproofing of seams in the overlapping area for horizontal joints

**Overlapping fastening element**



Used in case of horizontal joints

**Fastening clip**



Used for fixing the Products to the battens

**Cable fastening clip**



Used for fixing loose cables to the battens

**Hand seaming tool**

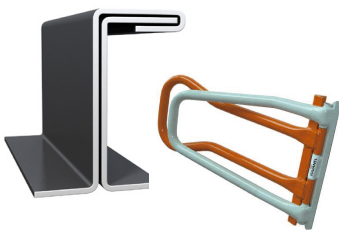

First seamer folder

**Hand seaming tool**



Second seam folder

**Electric seamer**



Can be used if no pressure is applied to the PV layer

**Metal cutter**



**Screwdriver**



**Seaming pliers**



## Cutting of the seams

Cutting the seam is only necessary if more than 2 seams are overlapped. The seam cut should be done only in the overlapping area.

### Case 1

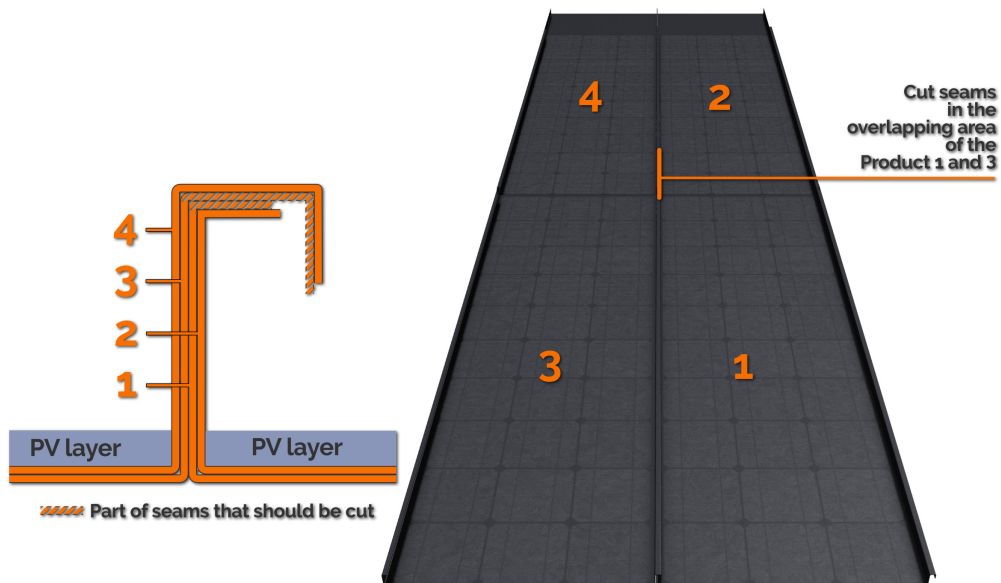

### Case 2

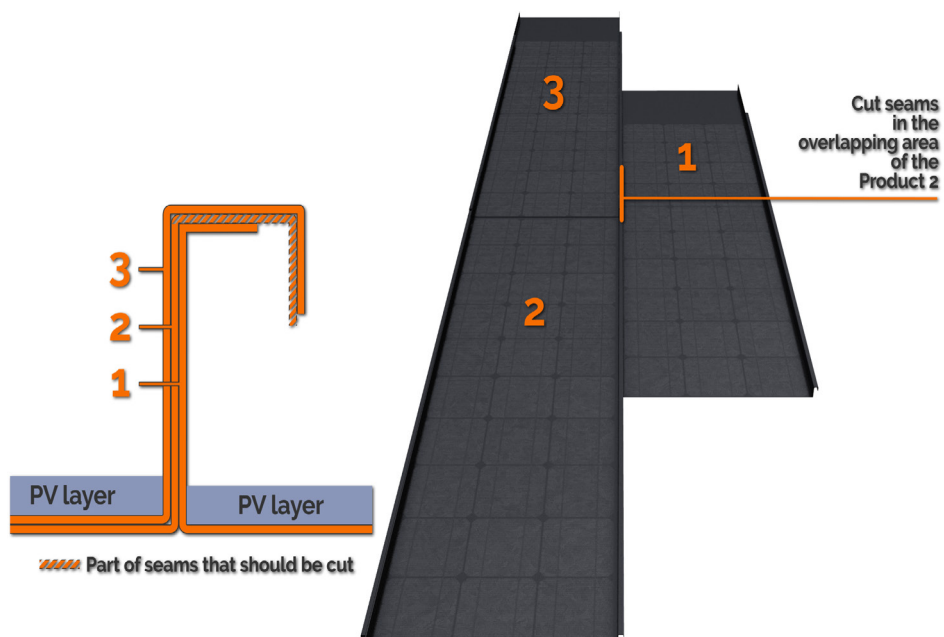



The seams need to be cut according to overlapping coverage area. The gap between the lower and upper PV layer can be changeable ensuring a minimum distance of 3 mm between the PV layers and a minimum overlapping area of minimum 200 mm. Cut the seams approximately 20mm shorter than the expected overlap. Example: If a minimum allowed gap of 3 mm is left between the PV-layers, then the seams should be cut approximately in the length of 280 mm.

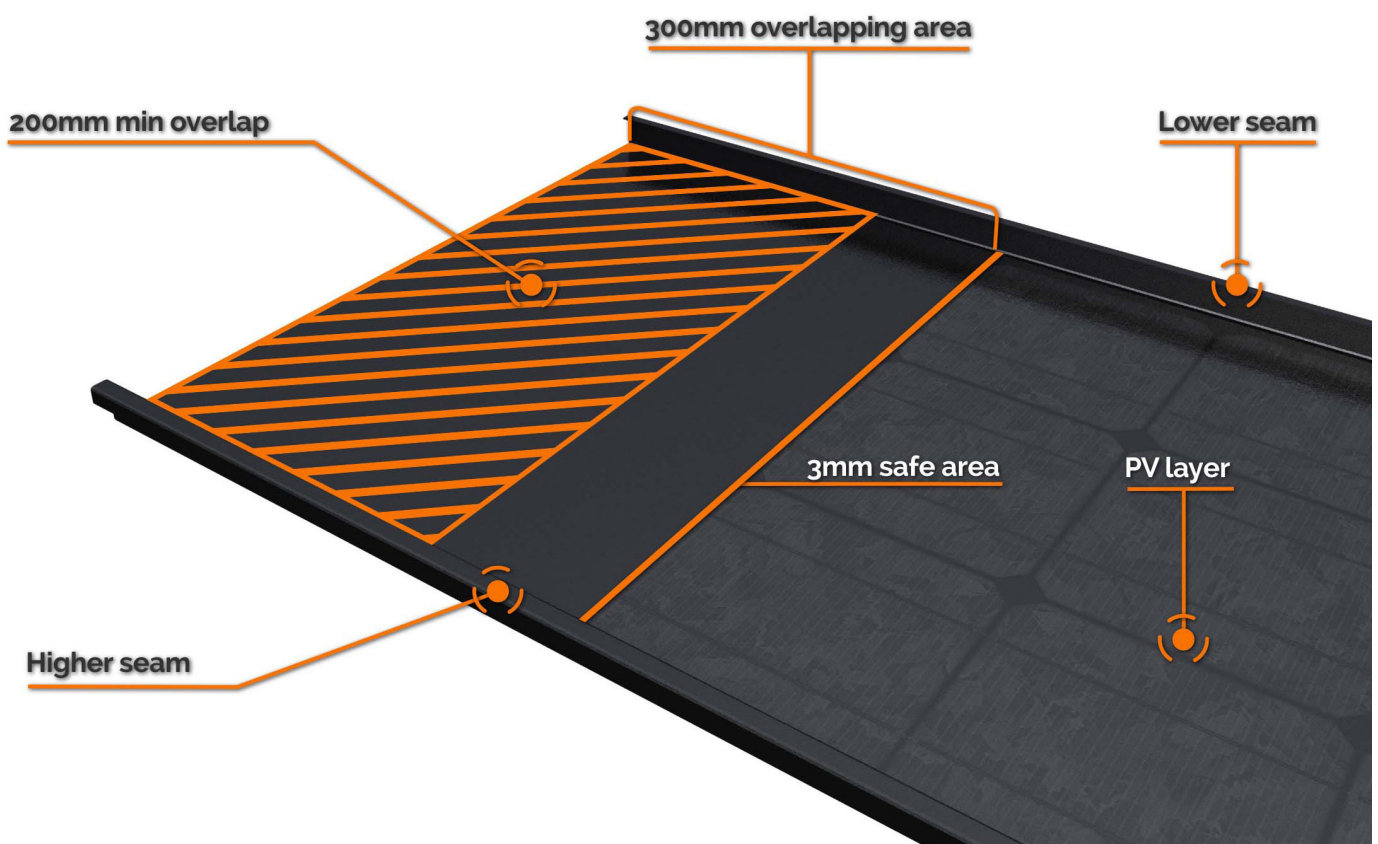



## Seaming of the double seam profile

The Product must be fastened with clips according to the double seam metal installation instructions. Fastening screws must be fully tightened.

Special attention is required during the seaming process of the Products with hand seaming tools or an electric seamer. Make sure the hand seaming tools or the rollers of the electric seamer do not touch the PV layer.

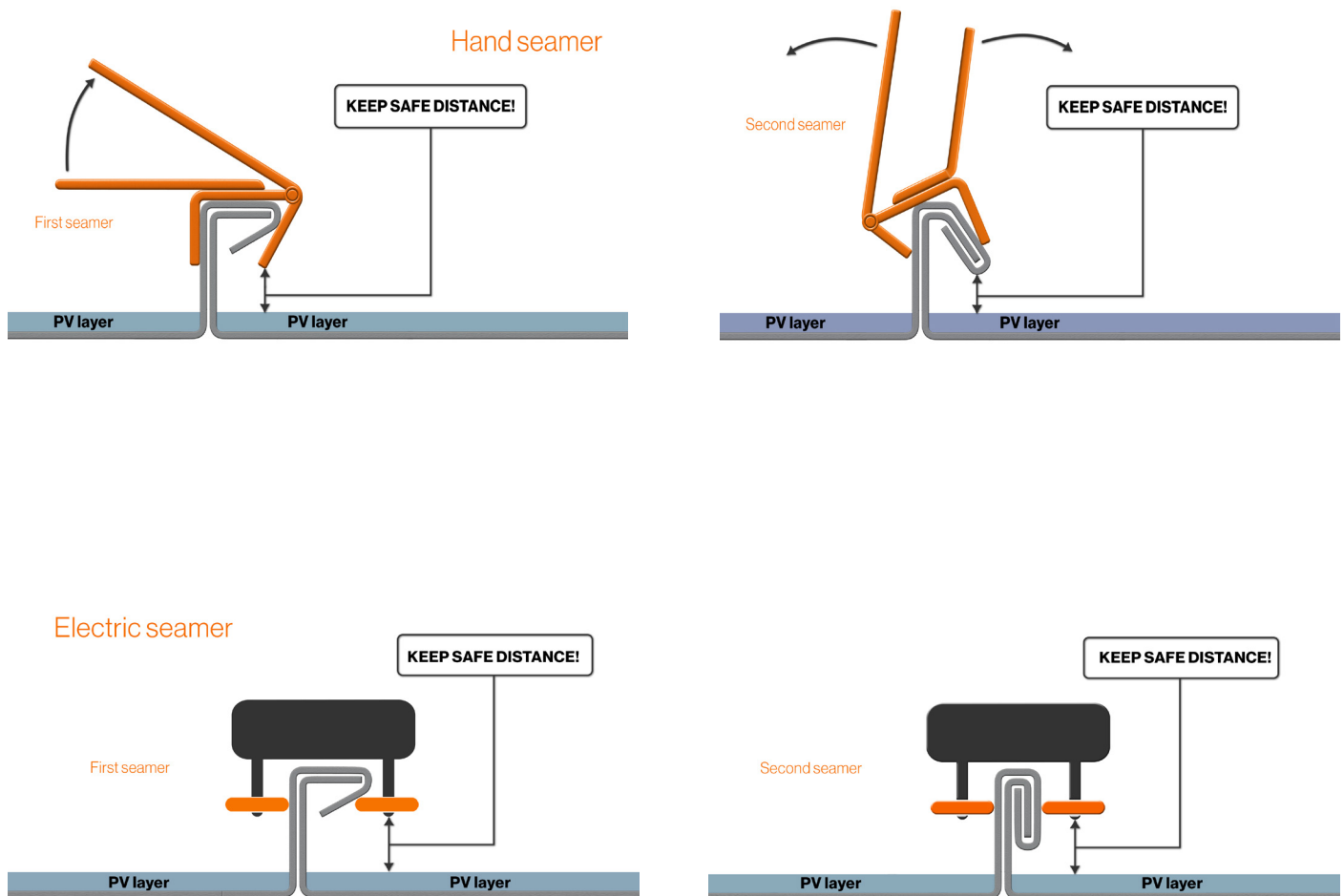

## Installation instructions

Depending on the roof dimensions, design or other needs, a Roofit.Solar products can either cover the entire roof or be used with regular metal. Below, 3 different installation scenarios are presented with only the most important aspect one must follow during the installation.

**Case 1 represents the most trivial scenario, where the full roof is covered with solar modules.**

**Case 2 describes installation, where the lower part of the roof is using regular metal.**

**Case 3 The upper part of the roof is using regular metal.**

Some of the steps in Case 1 are universal and won't be duplicated in the other cases, therefore in any case go through Case 1 and consult our technical support for any questions. Between Case 2 and Case 3 - Case 2 is preferable due to an easier installation process.

### Case 1: Roof fully covered with Roofit.solar modules

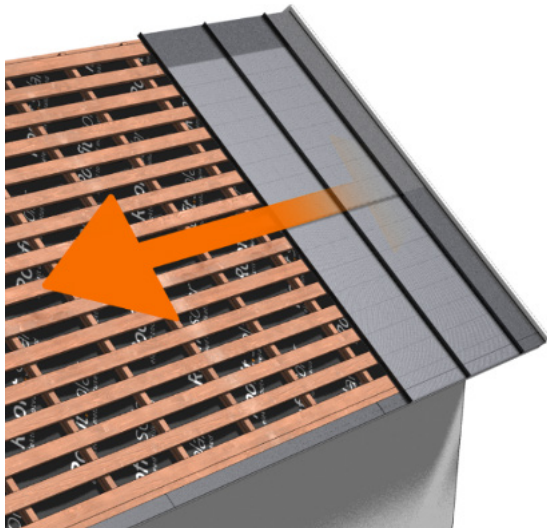

#### Step 1.

Begin with the rightmost column and start the first column with either PV module or a regular metal sheet depending on the roof planning layout.

Before starting, make sure to install the eave flashing in a continuous line, rather than overlapping it. Use insulation under the regular metal to prevent issues like oil canning and noise.

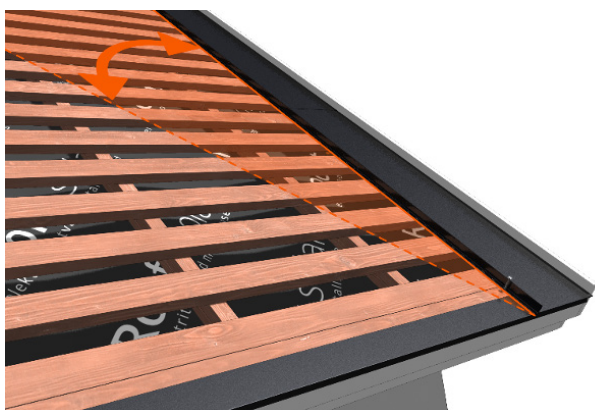

#### Step 2.

First, fix the roofing sheet with just one fastening clip at the bottom corner of the sheet.

Use extra caution when installing the first roofing sheet. Ensuring that the first roofing sheet is at a right angle to the eaves flashing will make the installation of the rest of the roof easier.

The right angle (90°) can be determined with a right-angled triangle equation  $A^2 + B^2 = \sqrt{C}$ , for example with dimensions of  $A=3m$ ;  $B=4m$ ;  $C=5m$ . Mark measurement A on the roofing sheet and B on the eaves flashing. Adjust the roofing sheet around the fixing point to achieve a value of exactly 5m for the line C.

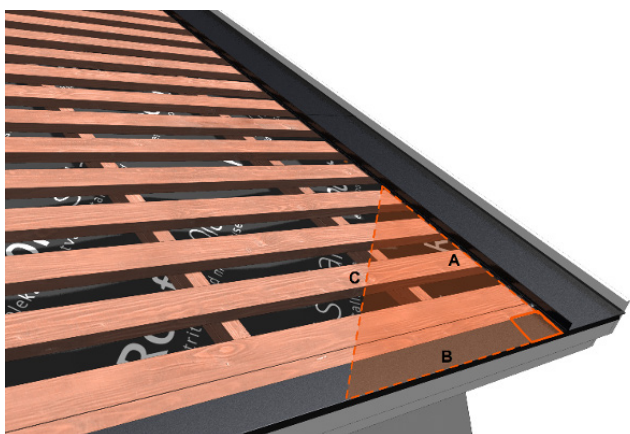

After the angle has been adjusted, fix the metal with more screws. General rule requires min. 7 screws/ m<sup>2</sup> for the roof. Areas with high wind speed require 10 screws/m<sup>2</sup>.

If you follow the recommended batten spacing of 200mm, both the PV module and passive metal require 1 screw for every second batten in the center part of the roof and 1 screw for every batten on the edges. A minimum of 200mm from the bottom edge of the roof should have full decking, and additional screws have to be used to ensure the proper fixation of the metal.

For regular metal sheet installation, refer to the Ruukki manual.

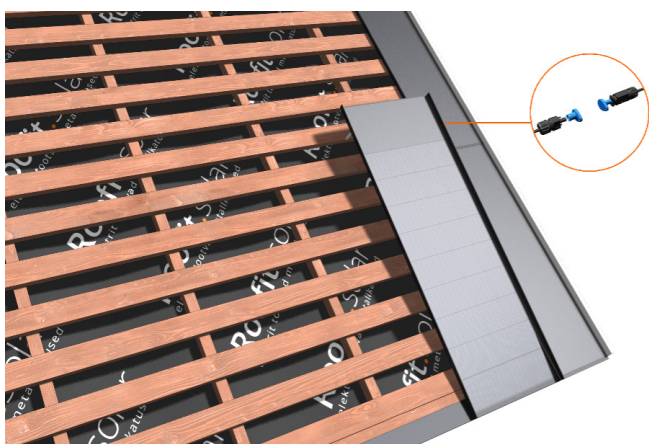

### Step 3.

Before fixing the PV module, cut the seams (if needed) and make sure to connect the cable with the previous module/inverter cable. Remove the dust caps and push the connectors together until you hear a \*click\*. Bring the second cable of the PV-module out from the side to ease the connection of the next module afterwards.

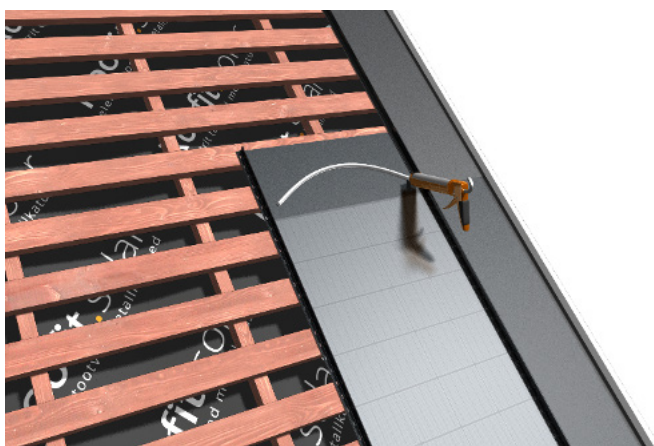

### Step 4.

Butyl sealant is applied in a curved line in the middle of the overlap section, leaving a few centimeters gap at the end for condensation water drainage.

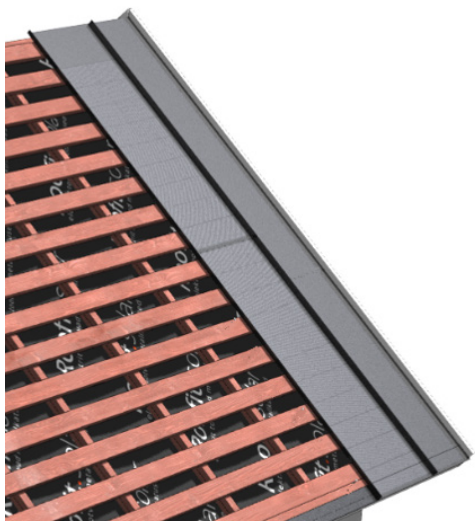

**Step 5.**

While placing the next module on top, make sure to leave minimum 3mm gap between two glasses.

## Case 2: The column starts with a regular metal sheet

Majority of the installation steps are similar to Case 1, except the lower part starts with regular metal. This layout is most used when show guard are needed.

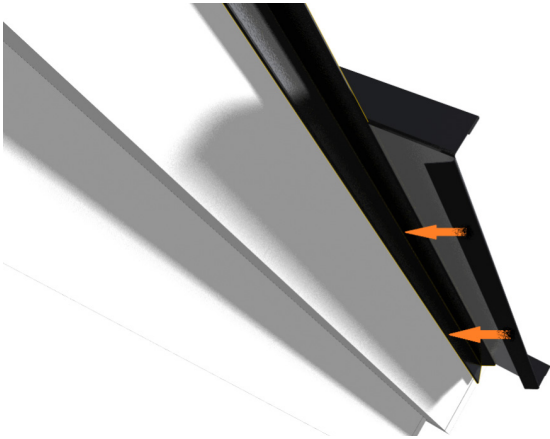

### Step 1.

The bottom sheet shall be installed as required in the Installation manual of the double seam metal with metal folding under the eave.

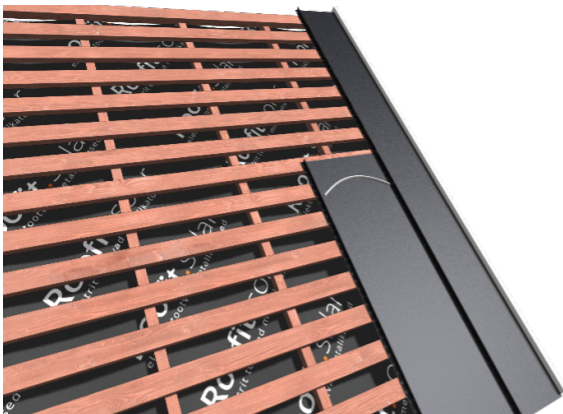

### Step 2.

Sound insulation band under the regular metal sheet helps to reduce wind noise and oil canning.

Attach the sealant to the upper edge of the standard metal sheet.

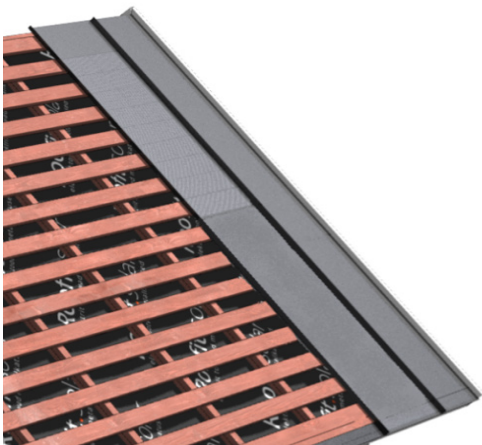

### Step 3.

Install the next PV module on top with a 200mm overlap



### Case 3: The column ends with a regular metal sheet



#### Step 1.

Prepare the top metal part by cutting the seams and forming a backband.

Place sound insulation band under the regular metal sheet.

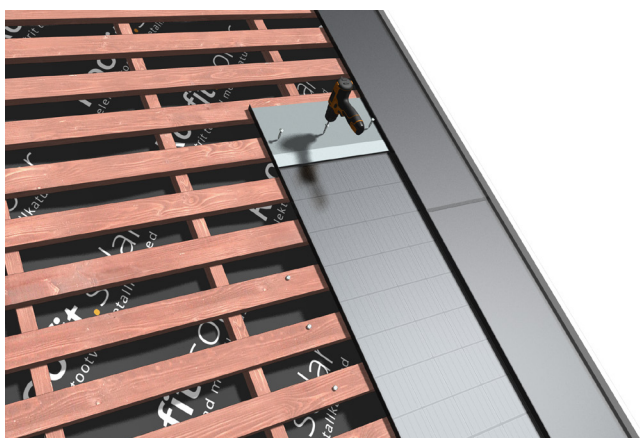

#### Step 2.

The seams in the Roofit.Solar Products overlapping area should be cut.

To install a regular metal sheet on top of the PV module, an overlap element is placed on the lower PV module. Overlap element is attached with 3 flat-head screws. In case there is no batten underneath the overlap area, install an additional batten. Bending of the lower side of the overlap element upwards also enables an easier installation of the next steps.

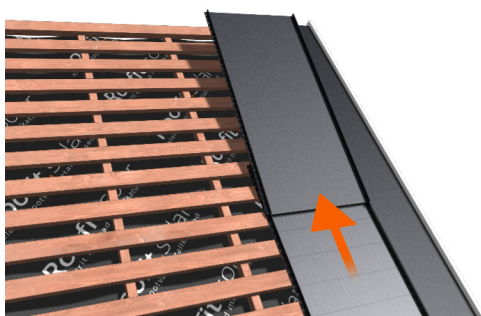

#### Step 3.

The folded end of the metal sheet must be inserted under the extension flashing and then pulled toward the ridge to fix it into place. Backband of the regular metal can be flattened with a wooden board and bumping mallet.

Pay attention not to hit the glass of the lower PV module.

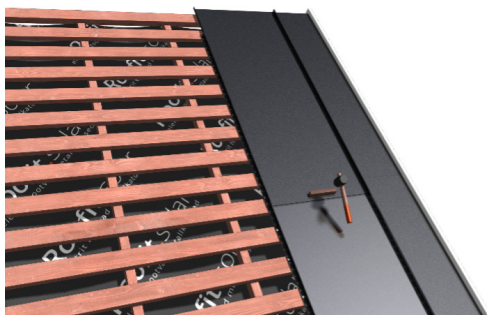



## Maintenance

Regular inspection and maintenance of the Products is necessary, especially within the Warranty Period. It is the user's responsibility to report any damage to the supplier within 4 weeks after their appearance.

Damages caused by insufficient or incorrect cleaning lead to withdrawal of the warranty conditions of Roofit Solar Energy OÜ.

### **Cleaning**

Dust accumulation on the glass may reduce power output and even cause regional hot-spot effects. Industrial emissions or bird droppings may also affect, and the degree of severity depends on the transparency of the foreign objects. Usually, the accumulated dust does not reduce the transparency much, as light intensity is still homogeneous and the reduction in power output is typically not visible.

Negative environmental effects, such as foreign objects casting shadows or laying directly on the roof, may adversely affect the power output of the Product. Roofit.Solar advises that the PV part of the system should not be obstructed at any time. The Product cleaning frequency depends on the environmental factors.

In many cases the glass is sufficiently cleaned by naturally occurring rain and the necessity to explicitly clean it is reduced.

Before cleaning, thoroughly inspect the Products for cracks or damage. Cleaning activities involve the risk of damaging modules and system parts, as well as increasing the risk of electric shock. Cracked or damaged modules present a risk of electric shock, and the risk increases if the modules are wet.

Before cleaning, make sure that:

- The circuit is switched off.
- The PV system string is disconnected from other active components (such as the inverter).

When cleaning the product, use a soft cloth, sponge or brush with soft bristles, making sure they are not abrasive to glass, silicone or metal. Cleaning should be carried out during the cooler period of the day (morning, evening) to avoid thermal stress on the module. Wear appropriate protective equipment (clothing, insulating gloves, etc.).

For lighter dirt (e.g. tree leaves, dust), we recommend using compressed air for cleaning. This solution can be used as long as the method is effective enough.

In case of noticeable dirt, it is recommended to gently wipe the glass surface with a damp sponge or soft cloth without touching any electrical connections. Do not use abrasive, acidic or alkaline cleaning agents and degreasing agents for cleaning.

### **Visual inspection**

Inspect the Products visually to detect any possible defects such as glass breakage.

It is recommended to implement the following preventive maintenance every 12 months (if accessible):

Check if the connectors are intact and encapsulated (i.e., the cables are not exposed).

Check the sealing gel of the junction box to locate any possible cracks or crevices.

## Decommissioning and Disposal

Roofit.Solar is strongly committed to protecting the environment. The Products are durable for decades and built of non-hazardous materials. When the Products have reached the end of their life cycle, they should be disposed in accordance with local recycling regulations.



Technical support shall be provided to the owner of the Roofit.Solar system by the Seller.  
For more information, please visit **Roofit.Solar website <https://roofit.solar/>**